

e3/13-100

Canon P.400

CINE PROJECTOR

INSTRUCTIONS



English Edition

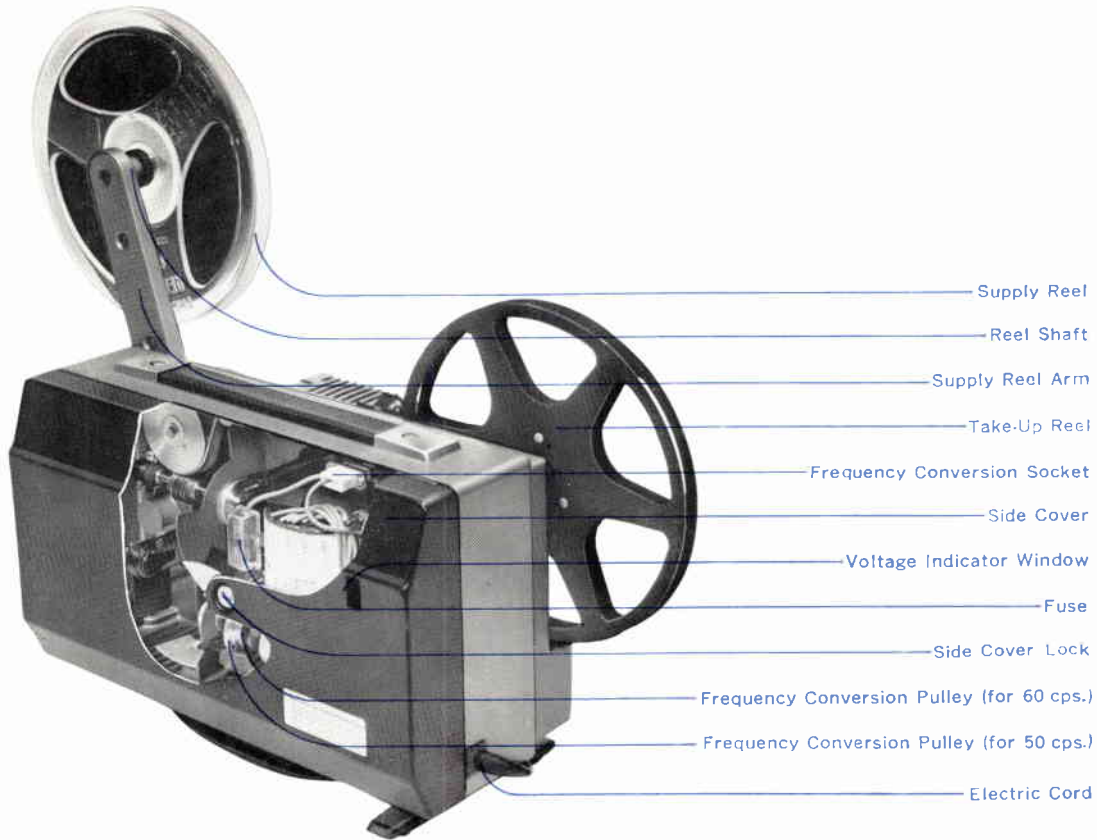

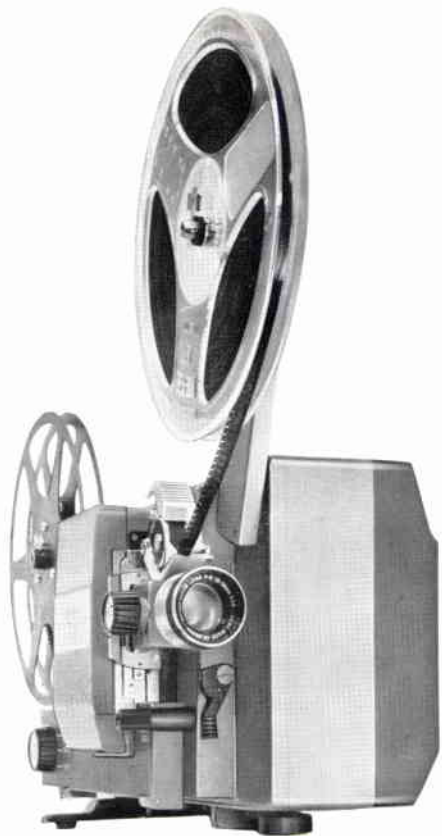

We are highly gratified that you have selected Canon Cine Projector P-400—a wise choice that promises you many delightful years of projection of your home movies.

Canon is recognized the world over as the foremost pioneer in the development of photographic equipments of the highest quality and performance.

Simple to operate, light and compact, Cine Projector P-400 is stable and specially made to add to the enjoyment of the entire family.

Your Projector Serial Number _____

Date of Purchase _____

Dealer's Name _____

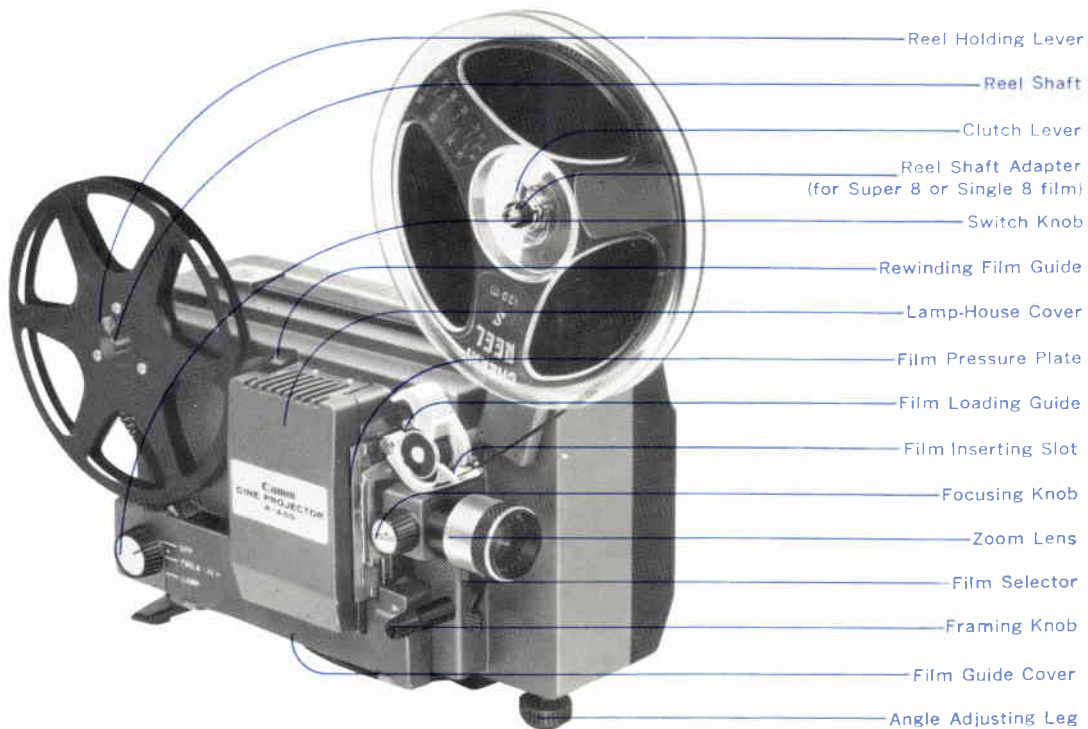

Reel Holding Lever

Reel Shaft

Clutch Lever

Reel Shaft Adapter
(for Super 8 or Single 8 film)

Switch Knob

Rewinding Film Guide

Lamp-House Cover

Film Pressure Plate

Film Loading Guide

Film Inserting Slot

Focusing Knob

Zoom Lens

Film Selector

Framing Knob

Film Guide Cover

Angle Adjusting Leg

Technical Data

Acceptable films

Film loading mechanism

Lens

Projection lamp

Motor

Acceptable voltages

Power consumption

Projection speeds

Reel capacity

Size

Weight

Super 8, Single 8 (4 x 5.4mm) films and regular 8mm (3.3 x 4mm) films by simply adjusting a built-in film selector. Loaded by placing film tip into the film inserting slot.

Canon zoom lens P-8 18-30mm F 1.4.

High brightness, low voltage lamp. 8V, 50W with a built-in reflector mirror. Philips type.

AC 100-240V, 50/60 cps.

Adjustable to nine voltages of 100, 110, 115, 125, 160, 200, 220, 230 and 240 with a built-in converter.

110W.

18 frames per second.

400 feet (121.9 meters).

285 x 175 x 147mm (11-1/4" x 6-7/8" x 5-3/4").

5.26 kg (11 lb. 9 oz.).

Subject to alterations.



Setting of Voltage

Before using Canon Cine Projector P-400, be sure to set the voltage switch at the voltage to be used. The fuse will blow out or the motor will not function if the voltage is not properly set.

To change the voltage, turn the voltage switch inside the voltage indicator window with a screwdriver until the desired figure appears.

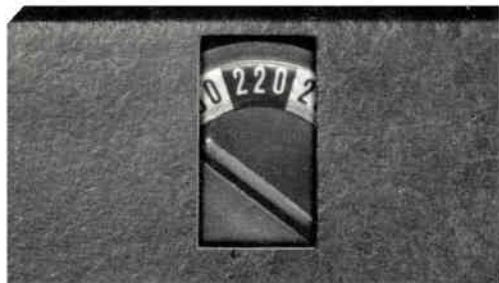

Preparations for Projection

1 When loading the film check the end of the film. In case the film is bent or any foreign substance is noticed on the film, cut this section with the film cutter separately supplied.

2 Set the film selector. Press down the lever of the film selector so that it shows "S" matching the red dot in front when projecting Super 8 or Single 8 film. In case of regular 8mm film, pull up the lever to show "R" instead.

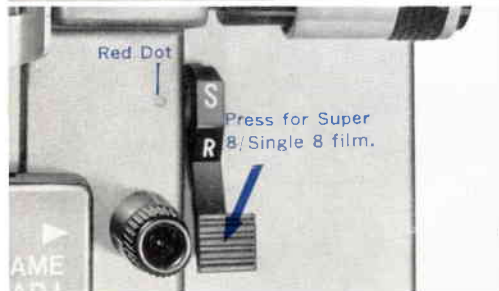
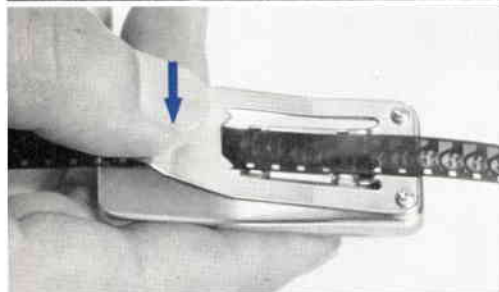

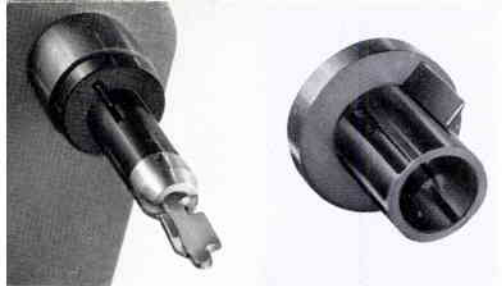

3 Pull up the supply reel arm all the way.

4 When projecting Super 8 or Single 8 film, insert the attached reel shaft adapter into the reel shaft matching the groove of adapter on the rib. Mount the supply reel with loaded film onto the reel shaft.

5 Bend the clutch lever of the supply reel shaft as shown in the illustration.

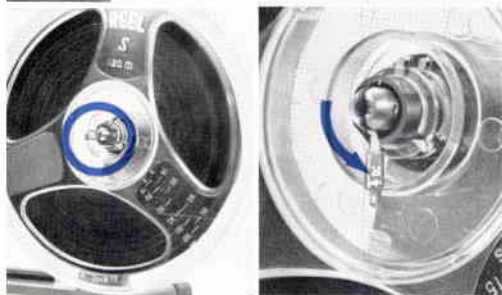

6 Lift up the reel holding lever on the take-up reel shaft. Mount the take-up reel onto the reel shaft. In this case, the reel side which does not have the grooves should be faced towards you. Then bend the reel holding lever.

7 Insert the plug into the power supply. The cord is approximately two meters (6.5 feet) long.

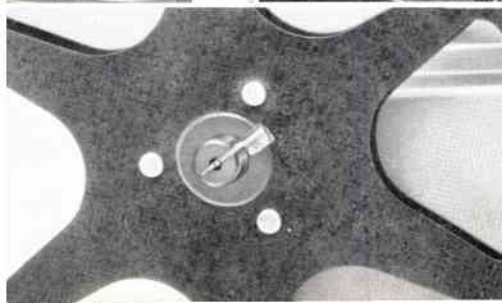

Pre-Adjusting for Projection

The power switch of the projector is 4-way system. When turned to the red dot, the motor is on; and starts functioning by turning to "FWD. & REW". The lamp lights up by turning the switch knob to "LUMP". Do not turn the switch knob abruptly.

- 1 Set up the projection screen.
- 2 Remove the lens cap.
- 3 Turn the switch knob to "LAMP" to see whether the picture is projected properly onto the screen evenly illuminated.
- 4 Make the height adjustment by turning the angle adjusting leg.
- 5 Determine the projection size by rotating the lens barrel of the zoom lens.
- 6 Adjust the focus by turning the focusing knob until the frames of the projected beam become sharp.

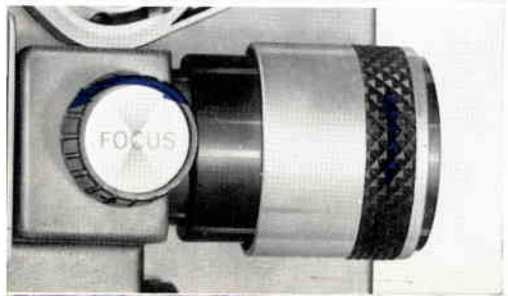
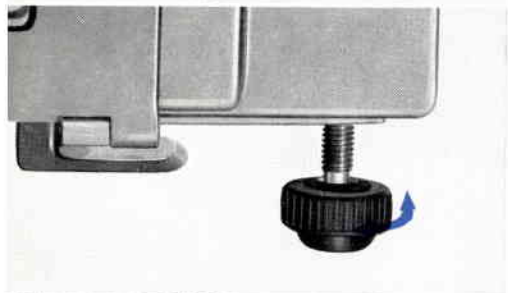
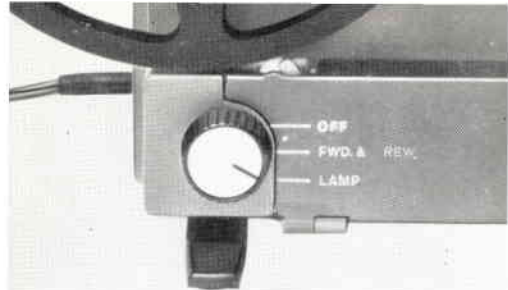

Film Loading and Projection

- 1 Turn the switch knob to the "FWD. & REW." position.
- 2 Insert the tip of the film into the film inserting slot in the direction of the arrow shown on the film loading guide while pressing down on the guide.
- 3 Keep pressing down on the film loading guide until the leader part of the film has completely passed through the pressure plate (approx. 12 cm, 5 inches). The take-up reel takes up the film automatically. Winding the film around the take-up reel is not necessary if the tip of film is curled inwards.
- 4 When the film has been properly taken up, turn the switch knob to "LAMP".
- 5 Make the fine adjustments for the focusing. The size of the projected image can be freely changed by turning the zoom lens barrel.
- 6 When the picture is cut off by the frame line, make adjustments by turning the framing knob.

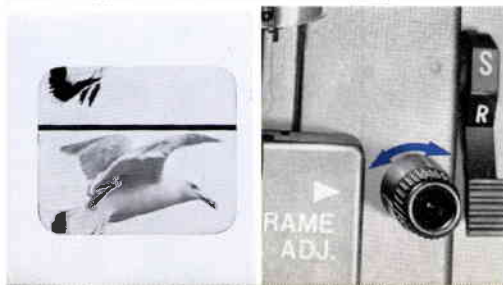
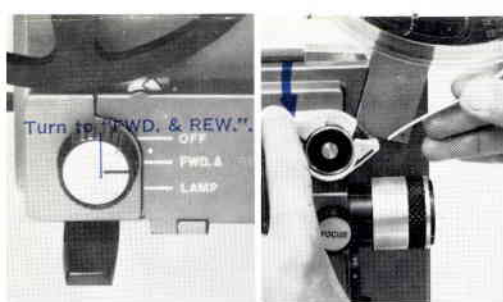

Pass the film on the Rewinding Film Guide.

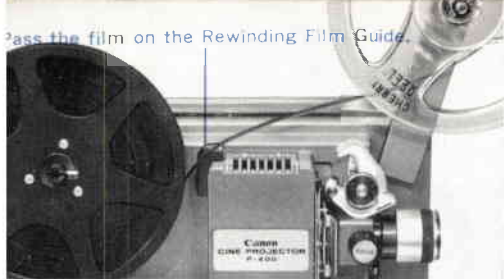

Film Rewinding

- 1 When projection has been completed, stop the film advance immediately by turning the switch knob to "OFF". Then wind up the film remaining in the film guide cover onto the take-up reel by hand completely.
- 2 Pass the end of the film on the film rewinding guide and insert it into the slot of the supply reel shaft.
- 3 Bend the clutch lever of the supply reel in the direction of the arrow shown on the lever.
- 4 Rewind the film by setting the switch at "FWD. & REW.".

Bend in the direction of the arrow.



Removing the Film in Mid-Projection

If it becomes necessary to remove the film before projection is completed, follow the instructions below:

- 1 Turn the switch knob to "OFF".

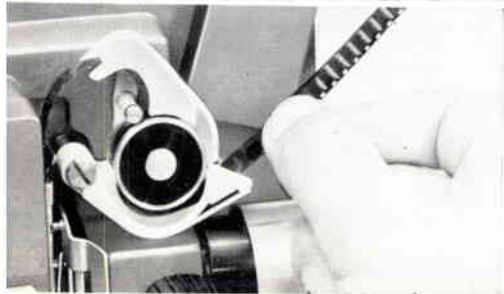

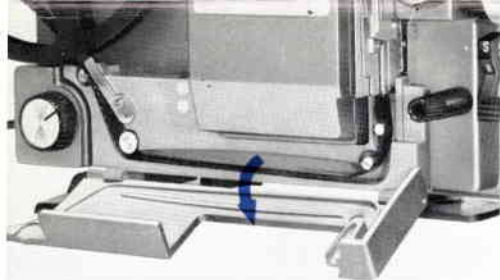

2 Remove the film from between the film loading guide and the rubber roller.

3 Open the film guide cover by pulling towards you from the top. Then remove the film from the guide.

4 Gently pull the pressure plate towards the lens to release the film and carefully disengage it from the film driving claws. If the film cannot be released smoothly, do not force it, but remove the lamp-house cover and rotate the shutter blade slowly by hand until the film is freed from the claws.



Proper Winding of Power Cord

Wind the power cord as illustrated in the picture when storing the projector equipped with the three-core power cord.

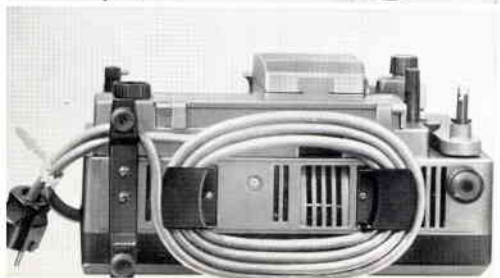

Changing of Frequencies

The frequency can be converted to either 50 or 60 cps to suit that of the locale in which the projector is to be used. The film will advance properly only when the frequency is adjusted correctly. Changing of frequency can be done as follows:

1 Open the side cover by inserting a coin into the groove of the side cover lock and turning it counter-clockwise.

2 If the projector is used at the locale of 50 cps, the supply belt should be around the larger pulley. If it is around the smaller pulley the frequency is set at 60 cps. Move the belt with your hand or a screwdriver if frequency conversion is necessary.

3 Set the frequency conversion plug so that the figure of the frequency to be used comes on top. For example, if the projector is to be used in 50 cps, set the plug into the socket showing the figure 50 on top.

Replacing of the Fuse

Check the fuse when the motor does not move after the power is switched on. Replace with the 3-ampere fuse by removing the fuse box inside the projector. In replacing the fuse, first disconnect the electric cord from the power supply.

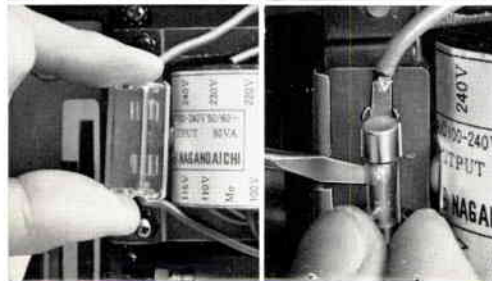
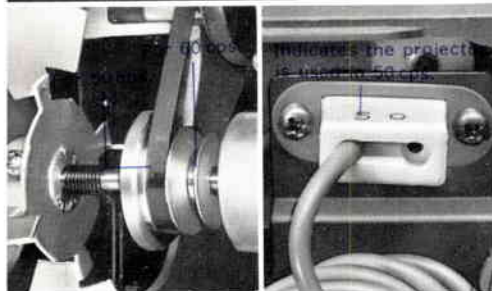

Replacing of the Lamp

When replacing the lamp, be sure to disconnect the electric cord from the power supply.

- 1 Remove the lamp-house cover by holding the upper part and pull it towards you.
- 2 Slightly press the lamp and turn it counter-clockwise as far as it will go, then pull it out.
- 3 Face the front of the new lamp and insert it fitting the holes to the socket guides, and turn it clockwise. Set the lamp-house cover after the lower part of the cover has been inserted.

Note: When the lamp is replaced, the light center position changes and there may be a slight unevenness in the brightness of the picture. In this case, loosen the two position adjusting screws of the lamp socket and adjust the position of the lamp by moving it to right or left. Then tighten the screws.

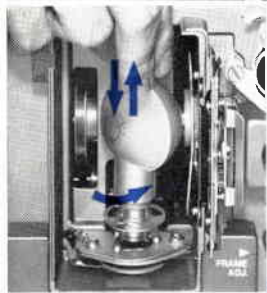
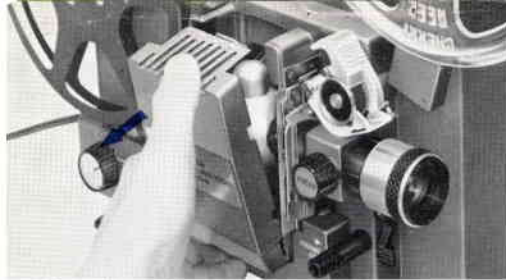

Position Adjusting Screws

Cleaning

The lens can be taken out while pulling the focusing knob towards you. Remove dust lightly with either a lens brush or silicon cloth. To clean the film gate, remove the pressure plate. First, protrude the zoom lens to the maximum extension by turning the focusing knob. Pull the pressure plate towards the lens, then towards you. Remove the dust lightly with the brush separately supplied.

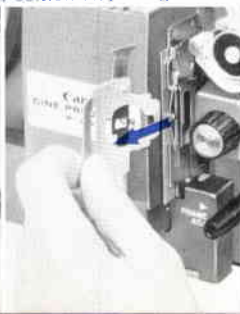

CANON CAMERA CO., INC.

9-9, Ginza 5-chome, Chuo-ku, Tokyo 104, Japan

CANON U.S.A., INC.

64-10 Queens Blvd., Woodside, N.Y. 11377, U.S.A.

CANON AMSTERDAM N.V.

Gebouw 70, Schiphol Oost, Holland

CANON LATIN AMERICA, INC.

Apartado 7022, Panama 5, Panama

PUB. NO. 5317F

1068N1.4

PRINTED IN JAPAN

